

Two-objective Optimization of Location and Geometric Characteristics of Rockfill Dams at Taleghan Basin using NSGA-II

Javad Sarvarian^{a,*}, Jamal Mohammad Vali Samani^b, Hosein Mohammad Vali Samani^c

^a Ph.D. Degree of Hydraulic Structures, Graduated from Tarbiat Modares University, Tehran, Iran

^b Department Hydraulic Engineering, College of agriculture, Tarbiat Modares University, Tehran, Iran

^c Department of Civil Engineering, College of engineering, Shahid Chamran University, Ahvaz, Iran

Received: 8 January 2018 /Accepted: 20 June 2018

Abstract

Among the structural and non-structural methods of flood control, rockfill dams are a kind of detention structures that increase travel time and reduce the maximum instantaneous flood discharge. Due to the rapid and automatic effect of these dams, flood reduction happens more quickly. In this research, the best arrangement of rockfill dams at Taleghan basin was determined based on the cost of rockfill dams and the outlet discharge peak criteria. For this purpose, "BRM" model, NSGAII and TOPSIS methods were used. The results of the model implementation for Taleghan basin indicated that the model has high accuracy and saves time of run. The final design cost is 74.4% less than the "all of dams" option. In addition, the final option has reduced the discharge peak by 64.9% compared to the "without any dam" option. At the final plan, the most of dams are allocated at the upstream areas of the basin and have been locating on the main river and the two reaches of Taleghan basin and there is no dam in the downstream of the basin (except the basin outlet).

Keywords: Flood Control, NSGA-II, Rockfill Dams, Taleghan basin, Two-objective optimization

Introduction

Among structural and non-structural methods of flood control, there are some methods in which flood management, can be done by determining the location and designing for the desired method. Flood control by reservoirs and detention basins is an example of these methods. By choosing the right position of these methods, the volume of the reservoirs and the cost of flood control measures can be greatly saved. The general recommendation in this regard is that the detention ponds should be constructed at the upstream of the basin (Hartigan, 1989).

Harrell and Ranjithan (2003) determined the most economical detention pond in City Lake basin at North Carolina by the concept of optimization. The optimization method was Genetic Algorithm. Results indicated that considering the location and the size of detention ponds simultaneously will significantly reduce the destructive effects of the flood. Shokouhi and

* Corresponding Author Email: j.sarvarian@gmail.com

Daneshvar (2007) investigated the impact of detention reservoirs in Abkharvar basin in comparison with the local river engineering operations for flood control in Behbahan city of Iran. Results indicated that flood control in the basin of the city in contrast to urban areas has economically and psychologically higher priority.

The most suitable design and location of flood control methods (BMPs) was provided by Chang and Huang (2009) to achieve the optimal environmental and economic goals. The results indicated that the best place to construct the BMPs, is near the outlet of the basin on the main river. Perez-Pedini et al. (2005), optimized the location and number of BMPs in order to reduce the peak flood hydrograph at the basin outlet using a combination of a rainfall - runoff model and the genetic algorithm. The results indicated that the optimal location and the number of BMPs is a complex function of basin network connectivity, basin delineation, land use and distance from the main flow path.

Ngo et al. (2016) used hydrologic simulation software (EPA-SWMM) with an evolutionary optimizer (extraordinary particle swarm optimization, EPSO) to minimize flood damage downstream while considering the inundation risk at the detention reservoir. The optimum design and operation are applied to an urban case study in Seoul, Korea. The result showed that the peak water level at the detention pond under optimal conditions is significantly smaller than that of the current conditions. The comparison of the total flooded volume in the whole watershed showed a dramatic reduction of 79% in a severe flooding event in 2010 and around 20% in 2011.

Oxley et al. (2014) presented a model for the design of detention basin systems by use of simulated annealing (SA) optimization procedure and the U.S. Army Corps of Engineer's Hydrologic Engineering Center - Hydrologic Modeling System (HEC-HMS). The objective function was the cost of detention basins and the decision variables were orifice area, orifice centerline elevation, spillway crest length, spillway crest elevation and surface area. The result indicated that simulated annealing is an effective tool in the optimal design of detention basin systems as compared to traditional standards of practice.

In most literature, the size and location of detention basins have been determined to minimize flood damage using different algorithms, such as nonlinear programming (Stafford et al., 2015) and dynamic programming (Travis et al., 2008). In addition, meta-heuristics algorithms such as genetic algorithm, simulated annealing, NSGAI and tabu search have also been used for this purpose (Oxley et al., 2014, Park et al., 2012, Yu et al., 2015 and Huang et al., 2015).

Rockfill dams are a kind of delayed structures that increase travel time and reduce the maximum instantaneous flood discharge. Due to the rapid and automatic effects of these dams, flood relief happens more quickly. Furthermore, due to the low cost of materials, simple design, rapid construction and high stability, these structures are one of the most suitable options for flood control (Stephenson, 1979). In general, the use of rockfill dam is a convenient and economical way to delay flooding (Samani et al., 2003).

Sarvarian et al. (2013) provided an optimal flood control plan at Taleghan basin, combining rockfill dams and coastal embankments (dykes). In their research, a goal function was to minimize the total cost of the rockfill dams and dykes. For this purpose, a simulation-optimization model was developed. Simulation of the flow was done by Pulse and Muskingum-Cunge methods and optimization was done using genetic algorithm. The results of model implementation for the Taleghan basin indicated that rockfill dams have great influence on flood hydrograph. In addition, to improve the flood relief efficiency of these dams and also to reduce the cost of the flood control project, it is advisable to construct rockfill dams at the middle and upstream of the basin.

Nikoo et al. (2016) determined characteristics of rockfill detention dams such as thickness of

detention rockfill dam and the optimum diameter of aggregates in the porous media using of Borda count social choice and Nash- Harsanyi bargaining models. The proposed model is on the basis of the multi-objective genetic algorithm model (NSGA-II) and the multilayer perceptron neural network. The objective function were maximizing the reduction in the flood peak discharge passing through the rockfill porous media of the dam and minimizing the increased flood duration. Results indicated that the optimum thickness of rockfill dam and optimum diameter of aggregates are 27.58 and 4.52 cm using of Nash- Harsanyi bargaining method. Also decision variables based on the Borda count social choice are 27.1 and 2.02 cm.

In this research, the optimal locations and arrangement of rockfill dams at the basin is determined based on the peak of basin outlet hydrograph and the cost of flood control plan criteria. For this purpose, the NSGAI multi-objective optimization and TOPSIS decision making methods are used.

Methodology

Case study

The study area of present study is Taleghan Basin, which is located at $36^{\circ} 05'$ to $36^{\circ} 21'$ north latitude, and $50^{\circ} 36'$ to $51^{\circ} 11'$ eastern latitude, at Alborz Province, Iran. The most important river of this basin is Taleghan River, which is the natural drainage of this region and flows from east to west and eventually discharges into Sefidrud River. In figure 1 the location of the case study on Iran map is shown.

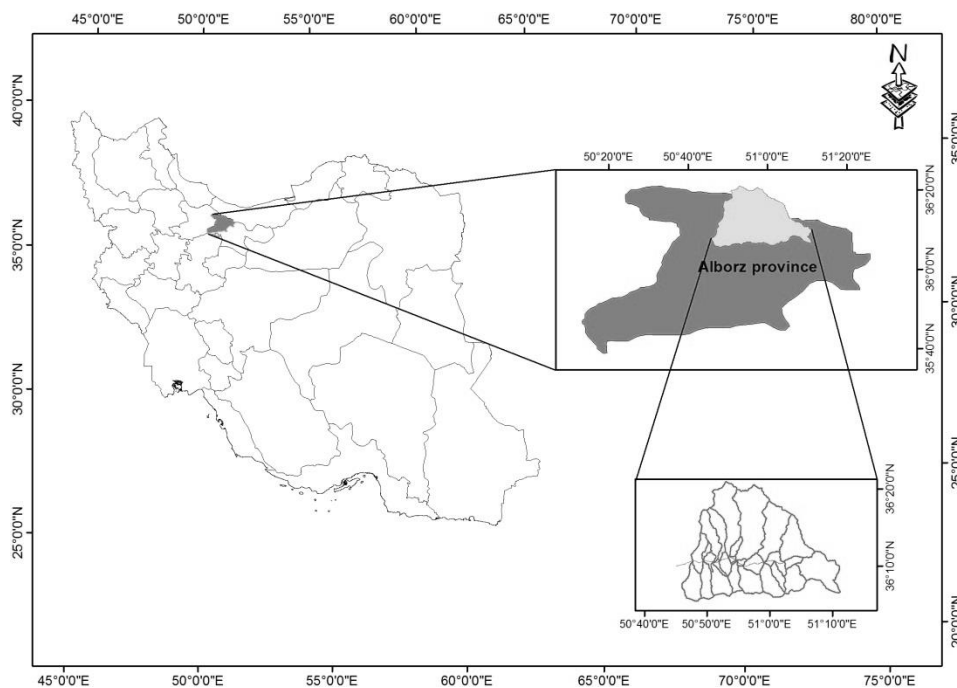

Figure 1. Locating of study area on Iran map

Taleghan drainage basins have 14 main reaches as shown in figure 1. To achieve the goals of this research, the initial location of the rockfill dams on the study reaches is determined based on topographical conditions, geological conditions, the existence of suitable materials and

environmental and social consequences. After the placement of rockfill dams, there were 75 study reaches with 48 dams. In figure 2, the study reaches of Taleghan basin, the location of rockfill dams and the residential area of Shahrak-e Taleghan, have been shown.

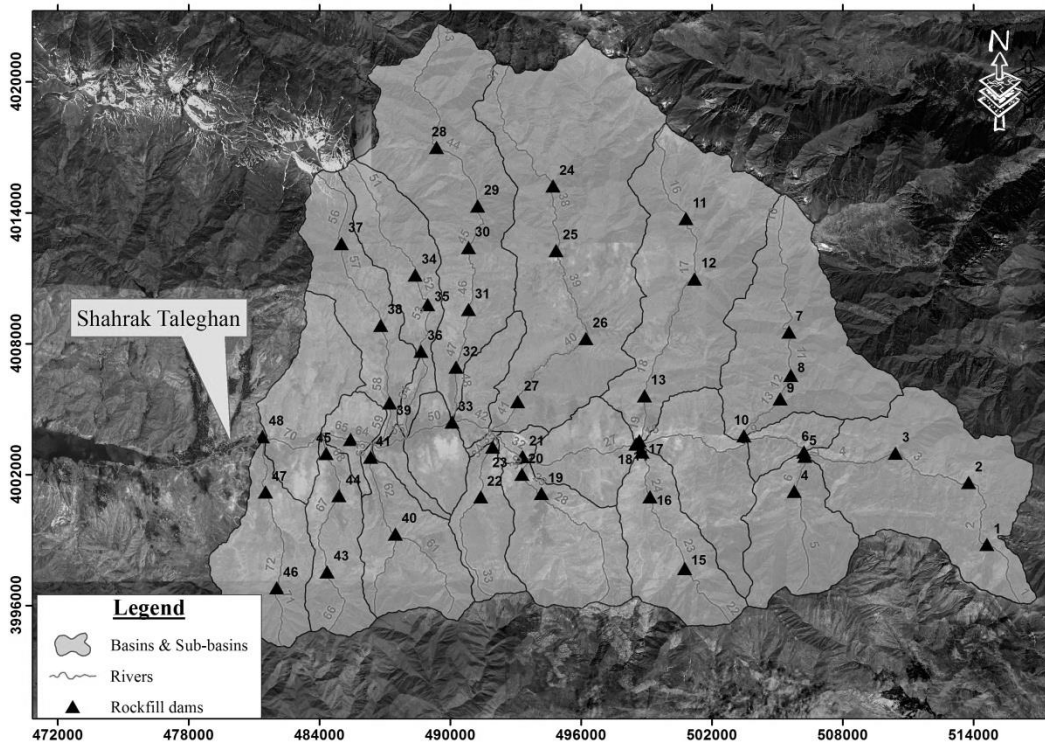

Figure 2. Study reaches with locating of rockfill dams and downstream residential area

Flood routing at the basin

The flow simulation model should be able to do flood routing operations, taking into account the set of rockfill dams and reaches. Flood routing is a mathematical method for predicting changes in flood wave velocity. In general, flood routing methods classified into three categories, including distributed, lumped and semi-distributed methods (Nourani and Mao, 2007).

The flood routing method at the reservoir of rockfill dams is the Pulse method. Additionally, the Muskingum-Cunge routing method is also used to route at reaches. Pulse method is based on the equilibrium between the inlet discharge, the outlet discharge and the amount of stored water in the reservoir. In this method, the amount of outlet discharge and the water stored in the reservoir are dependent on the height of the water surface elevation and the topographic conditions of the area (Chow, 1964). The basis of this method is to use the continuity equation as follows:

$$\frac{dS}{dt} = Q_o - Q_i \quad (1)$$

Where S is the amount of storage, Q_i is inflow discharge, Q_o is outflow discharge and dt is time step.

One of the necessary requirements for the Pulse method is the volume-elevation relation and the discharge-elevation relation (rating curve) for each rockfill dam. The volume-elevation relationship in this study was determined by using the digital elevation model (DEM) of the study area and using the 3D Analyst tool in the GIS environment.

In relation to the rating curve, the flow of water through rockfill dams should be considered unlike other dams in the flood routing calculations. So it is necessary to consider the hydraulic flow parameters through coarse porous media. The flow through rockfill dams is a turbulent flow and the relationship between hydraulic velocity and gradient will be non-linear (Li et al., 1998).

In this research, the relation of Samani et al. (2003) is used for the discharge-elevation relation at rockfill dams. For the natural flow channel and assuming the relation $A = \gamma y^\lambda$ between the cross section and flow depth, the relation is as follows:

$$H_{up}^{\lambda(b+2)+1} + K_1 K_2 H_{up} - K_1 L - H_{dn}^{\lambda(b+2)+1} = 0 \quad (2)$$

$$K_1 = \left(\frac{Q_{pulse}}{\delta \gamma} \right)^{b+2} [\lambda(b+2) + 1] \quad (3)$$

$$K_2 = 0.7z \quad (4)$$

$$\delta = \left(\frac{2g\nu^b}{a(d_{50} - \sigma)^{b-1}} \right)^{\frac{1}{b+2}} \quad (5)$$

Where H_{up} is upstream flow depth, H_{dn} is downstream flow depth, L is dam length in flow direction, Q_{pulse} is outlet discharge, z is steep slope, g is gravity acceleration, ν is kinematic viscosity, d_{50} is mean size of rocks, σ is standard deviation of rocks, a and b are the coefficients of friction factor - Reynolds number relation. Samani et al. (2003) by using experimental data and optimization concept, suggested value of a and b as 54 and -0.077, respectively.

The Maskingum-Cunge method is the development of Maskingum's method for determining the parameters of X as a dimensionless weighting factor and θ as flood wave travel time. In the Maskingum-Cunge method, these parameters depend on flow characteristics and geometric properties of the natural channel and this dependence is defined in such a way that the numerical diffusion matches the physical diffusion (Ponce, 1978). The accuracy of the Maskingum-Cunge method is acceptable especially on steep and mountainous rivers. Also due to the minimum need for mapping, it is a suitable method in rivers without hydrometric station and reliable statistics (Fotouhi and Maghrebi, 2010). To determine the values of X and θ at this study, the following equations are used:

$$X = 0.5 \left(1 - \frac{Q_{cunge}}{TS_o c_k \Delta x} \right) \quad (6)$$

$$\theta = \frac{\Delta x}{c_k} \quad (7)$$

Where Q_{cunge} is reference discharge, T is top of the water surface width, Δx is reach length, S_o is longitudinal river slope and c_k is kinematic wave celerity. If the discharge-area relation defined as $Q = \alpha A^\beta$ and the area-depth defined as $A = \gamma y^\lambda$, kinematic wave celerity and top water surface width can be estimated by:

$$T = \frac{dA}{dy} = \gamma \lambda y^{\lambda-1} \quad (8)$$

$$c_k = \frac{dQ}{dA} = \alpha \beta A^{\beta-1} \quad (9)$$

Where A is cross section area and y is flow depth.

In conventional Muskingum-Cunge methods, only one cross section of the waterway is used to express the natural flow channel geometry, which may lead to false calculations. In present study, the method presented by Kim and Jun in 2009 was used to estimate the Muskingum-Cunge parameters. In this method, based on equation 9, the kinematic wave celerity is determined by

regression analysis of cross-sectional areas and discharge values (Kim and Jun, 2009).

In present study a program was written in Matlab where by changing the arrangement of rockfill dams in the basin, the flow at reaches and through rockfill dams is calculated and the outlet hydrograph of the basin is estimated. In addition, the program calculates the volume of the rockfill dams and subsequently their cost based on geometric characteristics in each arrangement. This program is named "Basin Routing Model" or "BRM". In this model, there is a height where the flow which passes the rockfill dam will be through flow for all input hydrograph discharges. This height is considered as the height of rockfill dam.

Validation of the BRM model was evaluated in two separate sections. For flood routing at the basin, the output hydrograph was compared with flow dynamic analysis results in Mike 11 model. The results indicated that except at locations with low slopes, the model provided in this study predicts the peak of the output hydrograph and its occurrence time with high accuracy. Also, for validation of flood routing in rockfill dams, experimental data of flume in hydraulic lab of Tarbiat Modares University was used. The flume is a rectangular channel made of fiberglass that rockfill dam is placed inside it by units of gabions. Comparison of the results for several rockfill dams with different geometric characteristics and materials showed high correlation of the output hydrograph with rockfill dams in the BRM model and experimental data.

Optimization model

Simulation-optimization models are an effective alternative for complex and time-consuming numerical models (Zekri et al. 2015). Each optimization problem consists of four main parts including the decision variables, the objective function (functions), the constraints and the optimization method, which are as follows.

Decision variables

In this study, the variable X_i as the decision variable shows the position of rockfill dams at considered location. The value of this variable can be one or zero, which expresses, the existence or absence of a rockfill dam in location i .

Objective functions

The optimization problem of this research is a two-objective problem. The first goal is to minimize the cost of rockfill dams and the second goal is minimizing the outlet discharge peak from the basin. These two goals are in conflict with each other. In order to reduce the outlet discharge of the basin, it is necessary to use more of the rockfill dams, which will increase the cost of the flood control plan. The mathematical form of the first objective function is as follows:

$$\text{Min } FF_1 = \sum_{i=1}^n (C_i \times X_i) \quad , \quad X_i \in \{0,1\} \quad (10)$$

Where, FF_1 is the first objective function, C_i is the cost of materials in dam i , X_i is the decision variable and n is the number of dam permutations.

The value of C_i for each dam arrangement is a function of the dam volume and is calculated by results of the BRM model. The rock volume for construction of a dam with trapezoidal shape and at a natural section of waterway is calculated as follows:

$$V_i = \sum_{j=1}^m \frac{A_{i,j} + A_{i,j+1}}{2} \times (x_{i,j+1} - x_{i,j}) \quad (11)$$

$$A = (B + zH)H \quad (12)$$

$$z \in \{1.3, 1.4, 1.5\} \quad (13)$$

Where, V_i is the rock volume for construction of dam i , A is the cross section of dam in different section j , x is the distance of every section from beginning of dam, B is top width of dam, z is steep slopes and H is dam height. In figure 3, the parameters of the above equations are shown.

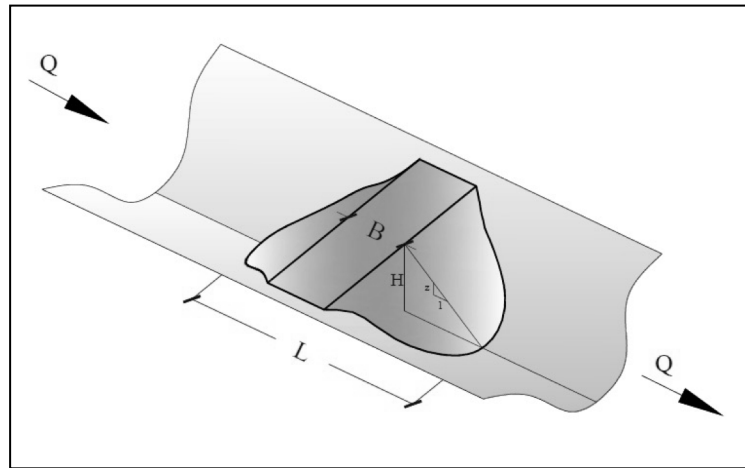

Figure 3. Graphical view of rockfill dam parameters

Generally, based on size and quality of rock materials and also considering stability issues, values of z are about 1:1.5 to 1:1.3. If the rock materials have low quality and the foundation is weak, slopes are less (Stephonson, 1979). It should be noted that in final design of rockfill dams, some considerations such as stability analysis must be investigated that in this study passed up. Also the value of current costs is taken as the percentage of rockfill dams cost (30 percent).

The mathematical form of the first objective function is as follows:

$$\text{Min } FF_2 = Q_{\text{out}} \quad (14)$$

Where FF_2 is the second objective function and Q_{out} is outlet peak discharge from the basin that is obtained from BRM model.

The only constraint with the current issue is the height of the rockfill dams. In a particular location, the height for a dam may be greater than the one which can be implemented in practice. Therefore, it is necessary to restrict the height of rockfill dams. In present study, this limitation is considered as the maximum height of the valley. In order to apply this constraint, the Adaptive Penalty Function method, presented by Yokota et al. in 1996, is used. In this method, the parameters of the penalty function are updated in each generation in accordance with the information of members of the community.

Optimization method

The problem presented in this paper is a sample of a two-objective optimization problem with nonlinear formulation that objective functions and constraint are expressed as non-explicit functions of the design variables, and to solve it, the Non-dominated Sorting Genetic Algorithm-II (NSGA -II) is used.

In this method, in addition to genetic algorithm operators such as selection, cross over, mutation, etc., two operators such as non-dominated sorting and crowding distance were used to form the Pareto Front and progresses in each step. In fact, the advantage of this method is to use the crowding distance to maintain the diversity of responses on the Pareto Front.

In figure 4, a chromosome (member of the community) is represented by multiple genes. Each gene represents a position for the rockfill dams. Genes can be one (existence of dam) or zero (absence of dam). All these randomly generated chromosomes will be the primary society of the optimization problem. The collection of these randomly generated chromosomes will be the initial population of the optimization problem.

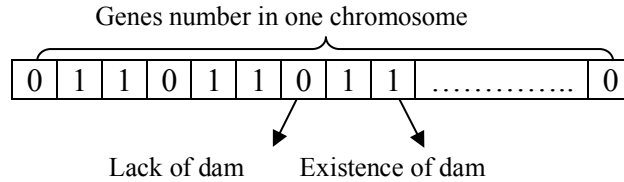

Figure 4. Sample chromosomes in the optimization algorithm

TOPSIS decision-making method

TOPSIS method was presented in 1981 by Hwang and Yoon, and later developed in 1993 by Hwang, Lai and Liu. This method is widely used in ranking problems. Its applications include water resources management, economics and environment, waste management, project management, urban management, etc.

In this method, m options are evaluated by n indexes. The logical principle of this model is the positive ideal solution and the negative ideal solution. Positive ideal solution increases the profit criterion and reduces the cost criterion. The optimal option has the least distance from this solution. Problem solving with TOPSIS requires six steps.

1- Formation of decision matrix as follows:

$$D = \begin{bmatrix} f_{11} & f_{12} & \dots & f_{1j} & \dots & f_{1n} \\ f_{21} & f_{22} & \dots & f_{2j} & \dots & f_{2n} \\ \dots & \dots & \dots & \dots & \dots & \dots \\ \dots & \dots & \dots & \dots & \dots & \dots \\ f_{i1} & f_{i2} & \dots & f_{i3} & \dots & f_{in} \\ \dots & \dots & \dots & \dots & \dots & \dots \\ \dots & \dots & \dots & \dots & \dots & \dots \\ f_{m1} & f_{m2} & \dots & f_{mj} & \dots & f_{mn} \end{bmatrix} \tag{15}$$

Where f_{ij} indicates the performance rate of each option according to any criterion.

2- Normalization of the decision matrix (R) as follows:

$$R = [r_{ij}] \tag{16}$$

$$r_{ij} = \frac{f_{ij}}{\sqrt{\sum_{i=1}^m f_{ij}^2}} , i = 1,2, \dots, m , j = 1,2, \dots, n \tag{17}$$

3- Calculation of weight matrix (V): This matrix is obtained by multiplying the matrix R in its weight as follows:

$$V = [v_{ij}] \tag{18}$$

$$v_{ij} = r_{ij} \times \omega_j, \quad i = 1, 2, \dots, m, \quad j = 1, 2, \dots, n \quad (19)$$

$$\sum_{j=1}^n \omega_j = 1 \quad (20)$$

4- Determining the positive ideal solution or the negative ideal solution as follows:

$$A^+ = \{(\max v_{ij} | j \in J), (\min v_{ij} | j \in J')\} = \{v_1^+, \dots, v_n^+\} \quad (21)$$

$$A^- = \{(\min v_{ij} | j \in J), (\max v_{ij} | j \in J')\} = \{v_1^-, \dots, v_n^-\} \quad (22)$$

Where J and J' represent criterions with a positive (profit) and negative aspect (cost), respectively.

5- Determining the distance between each option and positive ideals (S_i^+) and negative ideals (S_i^-) using Euclidean distance as follows:

$$S_i^+ = \sqrt{\sum_{j=1}^n (v_{ij} - v_j^+)^2}, \quad i = 1, 2, \dots, m \quad (23)$$

$$S_i^- = \sqrt{\sum_{j=1}^n (v_{ij} - v_j^-)^2}, \quad i = 1, 2, \dots, m \quad (24)$$

6- Determining the relative proximity of an option to an ideal solution:

$$C_i^* = \frac{S_i^-}{S_i^- + S_i^+} \quad (25)$$

7- Options ranking: Each option that has a higher C_i^* , has a higher priority.

In order to determine the proper arrangement of the rockfill dams in this study, the combination of the hydraulic simulation model and the optimization model is used. The flowchart of the computational steps is shown in figure 5.

Result analysis and discussion

In this section, the results obtained from the simulation-optimization model for the optimal flood control plan of Taleghan watershed are presented.

Input parameters of simulation model

To understand the geometry of the river and valley of the dam site, the coefficients α , β , γ and λ were determined for all 75 reaches of Taleghan basin. In addition, the length and longitudinal slope of reaches were obtained by regression analysis from the river thalweg. Manning roughness coefficient was determined based on field observations and completing the Cowan's method. The mean diameter of the rocks used in the rockfill dams was 600 mm and its porosity was 0.3. The steep slope of the rockfill dams in the present study was considered to be 1.3(H): 1(V). Hydrographs of Taleghan sub-basins were obtained by hydrological analysis based on a flood design with a return period of 25 years.

Also, the cost of rock per each tone for construction of the rockfill dams based on the price list of 2018 was considered 2 USD per ton. Taking into account 30% cost of execution and current costs, this amount is 2.6 USD per ton. With a specific gravity of 2.7 for stone materials, the volume of each tone will be 0.37 cubic meters. In other words, the cost of each cubic meter of rocks is 7 USD.

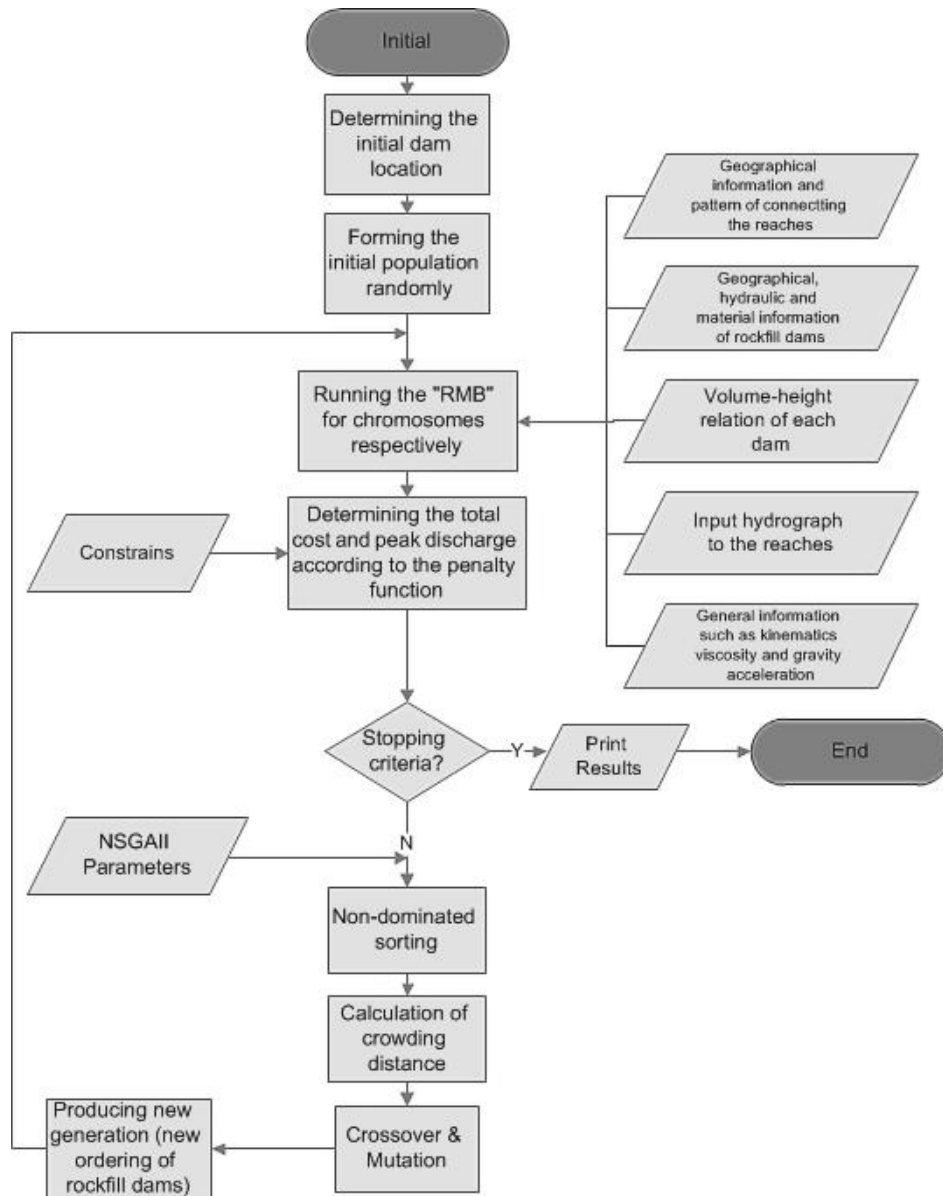

Figure 5. Flowchart of the simulation-optimization model

Input parameters of optimization model

In table 1, the coefficients and type of operators used in the NSGA-II model are shown.

In order to maintain the diversity of specifications and maximize the accuracy, 100 individuals were selected as the number of population. Studies showed that changing the number of population members did not change the Pareto's front. The rate of crossover and mutation in this research (0.8 and 0.02) are obtained by repeating the optimization model and examining the process of improving the response with different values.

Table 1. Input parameters of the NSGAI model

Parameters	Value or type
Number of generation	200
Number of population	100
Selection operator	Tournament
Crossover operator	Single point
Rate of crossover	0.8
Mutation operator	Uniformly
Rate of mutation	0.02
Crowding distance operator	Distance crowding

Pareto's front

The Pareto's front obtained from the NSGAI model is shown in figure 6. In this figure, the maximum outlet discharge from the basin (first objective function) is shown against the cost of rockfill dams (second objective function). The numerical values of this graph are also presented in table 2.

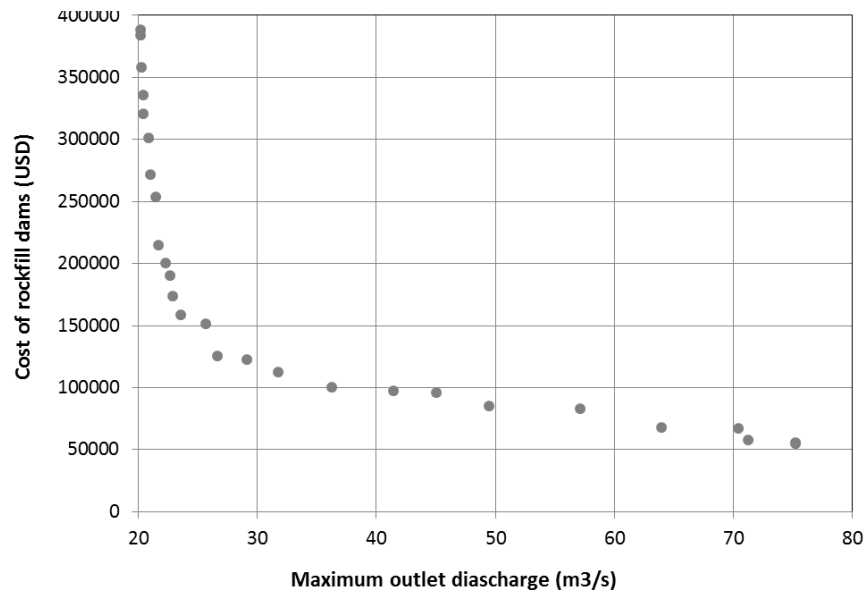

Figure 6. Pareto's Front of the NSGAI optimization program

The figure and table indicate that the final solutions have a good distribution on Pareto's Front. These solutions are the closest ones to the ideal solutions. As can be seen, by increasing the outlet discharge (reduction of the number of rockfill dams), the cost has also been decreased. All the Pareto's Front solutions are acceptable solutions for locating and designing of rockfill dams and the designers can select each of these solutions according to the specific conditions governing the project. In other words, based on the maximum outlet discharge from the basin, options 4, 5 and even 12 and 13 can be selected, and if the goal is to provide an economic flood control plan, options 1, 21, and 17 and 2 can be elected.

The final flood control option

To find the optimal arrangement of rockfill dams in this research, TOPSIS decision making method was used and the final design of the flood control plan is determined. In this method, the cost of rockfill dams and the maximum discharge of the outlet flood hydrograph were considered as criteria. The coefficients of both criteria were considered 0.5 which indicates that both criteria have the same importance. Finally, by applying this method on flow and cost data, the values of C_i^* were determined and the result is shown in figure 7. As can be seen, the scenario of number 19 has the highest C_i^* and is selected as the final option of Taleghan watershed flood control plan.

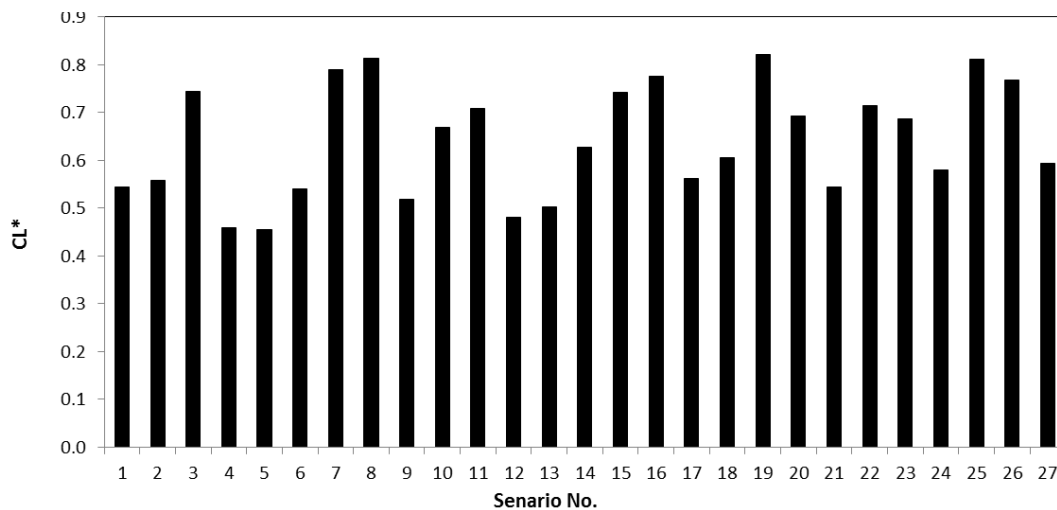

Figure 7. Variation of C_i^* at the TOPSIS method

In order to evaluate the cost and peak outlet discharge values in the selected option, a comparison was made between this option (19) and the two special modes. One not considering any of dam and the other taking into account all the dams. The results of this comparison are shown in table 4. In this table relative cost percentage indicates the variations of the cost to "all of dam" option and relative discharge peak percentage indicates the variation of the discharge peak to "without any dam" option.

Table 4. Comparison of the final flood control plan with two special modes

	Cost of rockfill dams (USD)	Discharge peak of outlet hydrograph (m ³ /s)	Relative cost percentage (%)	Relative discharge peak percentage (%)
Without any dam	0	76.1	-100	0.0
All of dams	489000	21.7	0.0	-71.5
Final design (19)	125453	26.7	-74.4	-64.9

As can be seen, the cost of the final design is 74.4% less than the "all of dams" option. In addition, the final option has reduced the discharge peak by 64.9% compared to the "without any

dam" option. Furthermore, by comparing the output hydrographs for the three modes of table 4, it can be seen that for final option, the distribution and elongation of the output hydrograph is significant and the flood control option has been able to control the severity of flood very well. The output hydrographs have been shown in figure 8. In this figure, diffusion and broadening of the final option output hydrograph is significant and the selected flood control option has been able to control the severity of flood very well.

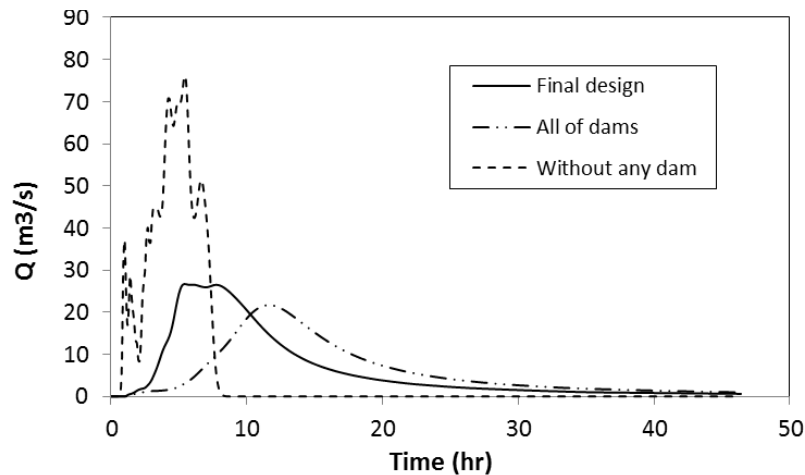

Figure 8. Comparison of the final design hydrograph with two special modes of table 4

In figure 9, proposed sites of rockfill dams in Taleghan basin are shown. In this figure, rockfill dam's heights are shown beside each dam.

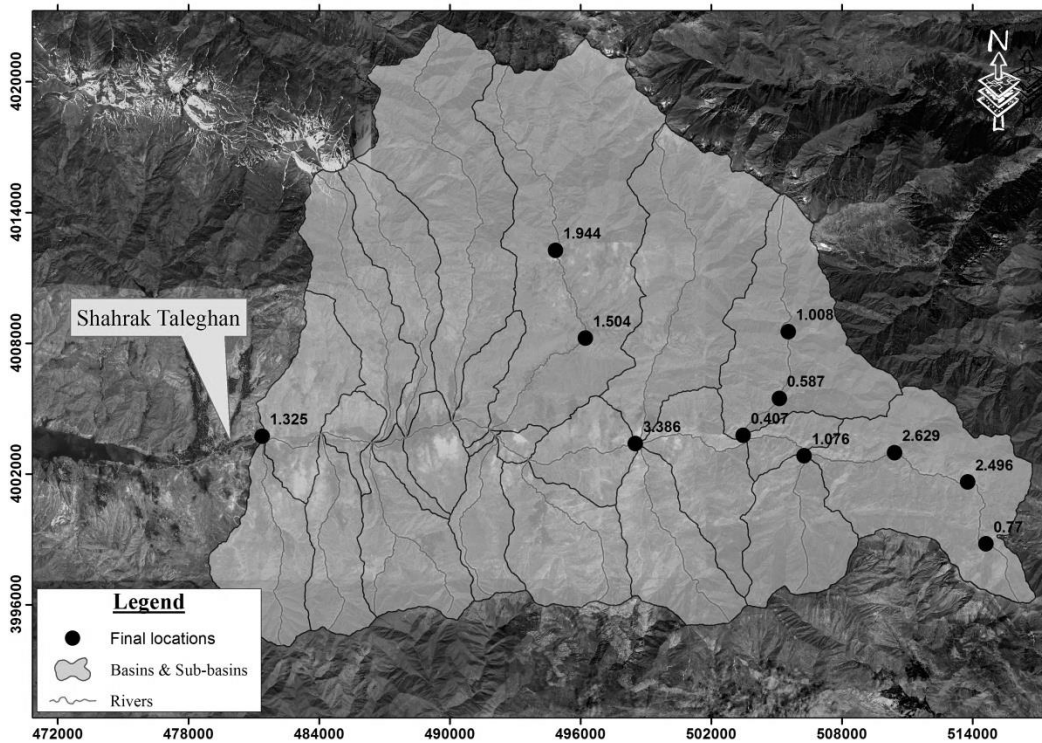

Figure 9. Final arrangement of the rockfill dams in the Taleghan basin

As seen in the above figure, most the dams are allocated at upstream areas of basin and have been locating on the main river and the two reaches of Taleghan basin. In other words, there is no dam downstream of the basin (except the basin outlet).

Conclusion

In this research, the best location and arrangement of rockfill dams in Taleghan basin was determined. At the most of littratures only economical (Harrell and Ranjithan, 2003, Shokouhi and Daneshvar, 2007, Chang and Huang, 2009, Oxley et al., 2014 and etc) or hydraulical (Perez-Pedini et al., 2005, Ngo et al., 2016, Nikoo et al., 2016 and etc) criteria was used. But these criteria are in conflict with each other. So in this study both economical (the cost of rockfill dams) and hydraulical (the outlet discharge peak) criteria were applied. To simulation of flow in the basin, the "BRM" model was used and the NSGAI method was used for optimization based on the above mentioned criteria. The results of the model implementation for Taleghan basin indicated that the model has great accuracy and saves time of run. The final design cost is 74.4% less than the "all of dams" scenario. In addition, the final scenario has reduced the discharge peak by 64.9% compared to the "without any dam" option. The diffusion and the broadening of the final option output hydrograph is significant and the selected flood control option has been able to control the severity of the flood very well. At the final plan, most of the dams are allocated in upstream of the basin and have been locating on the main river and the two reaches of Taleghan basin and there is no dam in downstream of the basin (except the basin outlet). In other words, to increase the flood control efficiency and to decrease the cost of flood control, it is better to construct rockfill dams in the middle and upstream of the basin which is consistent with the results of other researchers (Hartigan, 1989, Shokouhi and Daneshvar, 2007 and Sarvarian et al., 2013 and etc).

References

- Chang, C. L., Lo, S. L., & Huang, S. M. (2009), Optimal strategies for best management practice placement in a synthetic watershed, *Environmental monitoring and assessment*, 153(1-4), 359-364.
- Chow, V. T. (1964), *Handbook of applied hydrology*, McGraw-Hill, New York, NY.
- Fotuhi M, Maghrebi MF (2011), The Impact of effective parameters on muskingum-cunge in comparison with dynamic routing. *Iran-Water Resources Research* 7(1), 26-37.
- Harrell, L. J., & Ranjithan, S. R. (2003), Detention pond design and land use planning for watershed management, *Journal of Water Resources Planning and Management*, 129(2), 98-106.
- Hartigan, J. P. (1989), Basis for design of wet detention basin BMP's. In *Design of urban runoff quality controls* (pp. 122-143). ASCE.
- Huang, C. L., Hsu, N. S., Wei, C. C., & Luo, W. J. (2015), Optimal spatial design of capacity and quantity of rainwater harvesting systems for urban flood mitigation. *Water*, 7(9), 5173-5202.
- Hwang, C. L., & Yoon, K. (1981), Methods for multiple attribute decision making. In *Multiple attribute decision making* (pp. 58-191). Springer, Berlin, Heidelberg.
- Kim, J. S., & Jun, K. S. (2010), Estimation of Muskingum-Cunge Parameters for Natural Streams, *Journal of Korea Water Resources Association*, 43(2), 233-243.
- Lawrence, D., (1991), *Handbook of Genetic Algorithms*. Van Nostrand Reinhold.
- Li, B., Garga, V. K., & Davies, M. H. (1998), Relationships for non-Darcy flow in rockfill. *Journal of Hydraulic Engineering*, 124(2), 206-212.

- Ngo, T. T., Yoo, D. G., Lee, Y. S., & Kim, J. H. (2016). Optimization of upstream detention reservoir facilities for downstream flood mitigation in urban areas. *Water*, 8(7), 290.
- Nikoo, M. R. & Khoramshokoh N., (2016), Multi-Objective Optimum Design of Detention Rockfill Dam Characteristics Considering Hydraulic Conditions: Application of Borda Count Social Choice Method and Nash-Harsanyi Bargaining Mode, *Water and soil science journal*, 26(2), 13-25.
- Nourani, V., & Mano, A. (2007), Semi-distributed flood runoff model at the subcontinental scale for southwestern Iran. *Hydrological Processes: An International Journal*, 21(23), 3173-3180.
- Oxley, R. L., & Mays, L. W. (2014). Optimization–simulation model for detention basin system design. *Water resources management*, 28(4), 1157-1171.
- Park, M., Chung, G., Yoo, C., & Kim, J. H. (2012), Optimal design of stormwater detention basin using the genetic algorithm. *KSCE Journal of Civil Engineering*, 16(4), 660-666.
- Perez-Pedini, C., Limbrunner, J. F., & Vogel, R. M. (2005), Optimal location of infiltration-based best management practices for storm water management, *Journal of water resources planning and management*, 131(6), 441-448.
- Ponce, V. M., & Yevjevich, V. (1978), Muskingum-Cunge method with variable parameters, *Journal of the Hydraulics Division*, 104(12), 1663-1667.
- Samani, H. M., Samani, J. M., & Shaiannejad, M. (2003), Reservoir routing using steady and unsteady flow through rockfill dams, *Journal of Hydraulic Engineering*, 129(6), 448-454.
- Sarvarian, J Samani J M V, Samani H M V. (2012), Optimization of Flood Control by a combination of Detention Rockfill Dams and Dikes, *Journal of Hydraulic*, 7(2)27-45.
- Shokouhi, A. and Daneshvar, Sh. (2007), Study of the effect of detention dams and river engineering operations on the floodwater control of urban basins, *The Journal of Iran-Water Resources Research*, 3(1), 80-83.
- Stafford, N., Che, D., & Mays, L. W. (2015), Optimization model for the design of infiltration basins. *Water Resources Management*, 29(8), 2789-2804.
- Stephenson, D., (1979), *Rockfill in Hydraulic Engineering*, Elsevier Science Publishers, New York, USA.
- Travis, Q. B., & Mays, L. W. (2008). Optimizing retention basin networks. *Journal of Water Resources Planning and Management*, 134(5), 432-439.
- Yokota, T., Gen, M., Ida, K., & Taguchi, T. (1996), Optimal design of system reliability by an improved genetic algorithm, *Electronics and Communications in Japan (Part III: Fundamental Electronic Science)*, 79(2), 41-51.
- Yu, P. S., Yang, T. C., Kuo, C. M., & Tai, C. W. (2015), Integration of physiographic drainage-inundation model and nondominated sorting genetic algorithm for detention-pond optimization. *Journal of Water Resources Planning and Management*, 141(11), 04015028.
- Zekri, S., Triki, C., Al-Maktoumi, A., & Bazargan-Lari, M. R. (2015), An optimization-simulation approach for groundwater abstraction under recharge uncertainty. *Water resources management*, 29(10), 3681-3695.

